

TORRANCE STEEL WINDOW CO., INC.

CENTURY 2000 - BLOCK FRAME

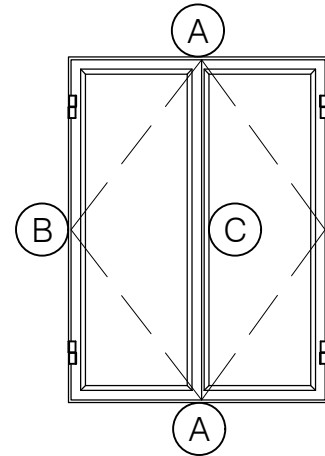
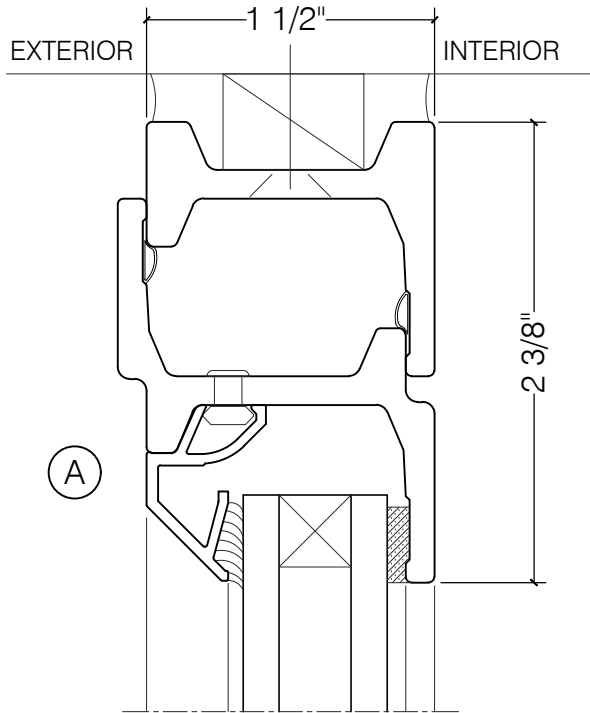

DOUBLE CASEMENT

$\frac{3}{4}''$ GLASS

