

TORRANCE STEEL WINDOW CO., INC.

CENTURY 2000 CASEMENT/FIXED COMBINATION

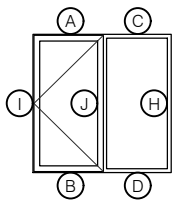

CASEMENT/FIXED

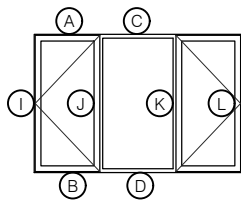

CASEMENT/FIXED/CASEMENT

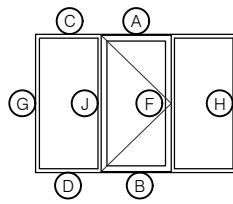

FIXED/CASEMENT/FIXED

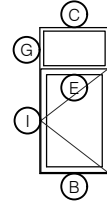

FIXED OVER
SINGLE CASEMENT

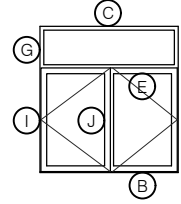

FIXED OVER
SINGLE CASEMENT

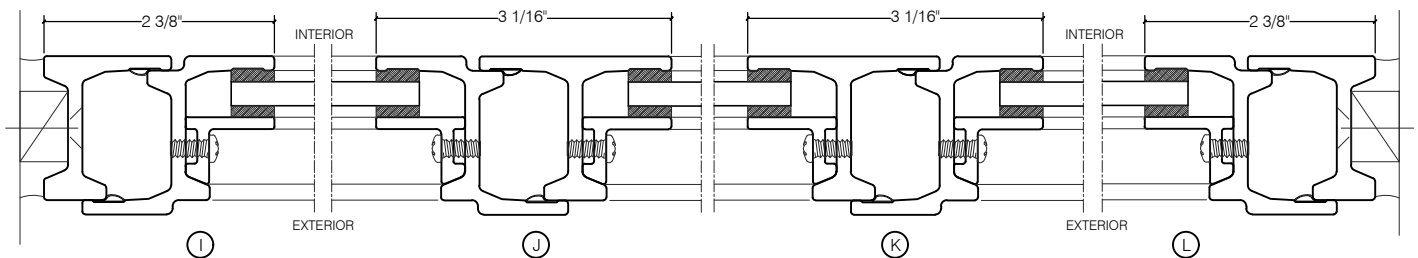
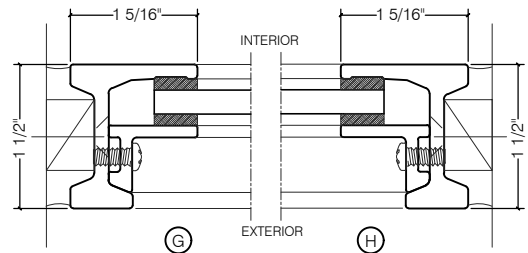
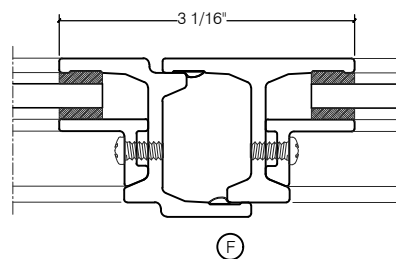
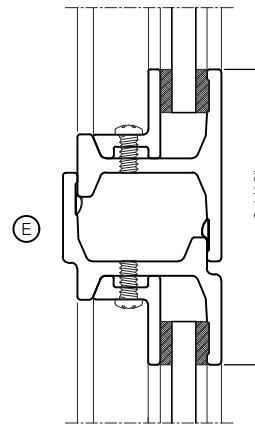
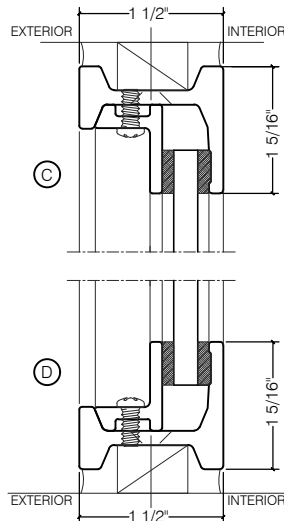
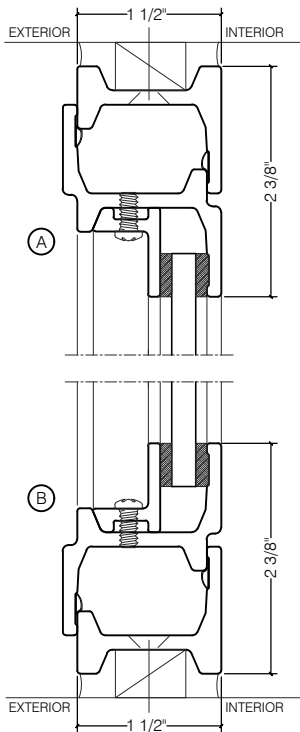

SCALE: 2:1