

TORRANCE STEEL WINDOW CO., INC.

JEFFERSON 1900 - BLOCK FRAME

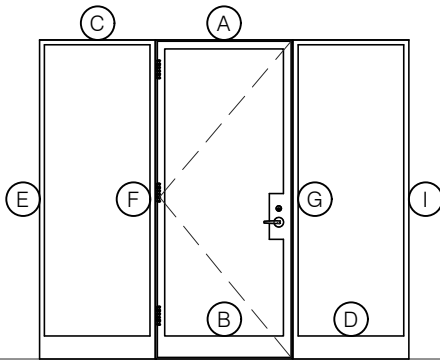

SWING IN
5/8" GLASS

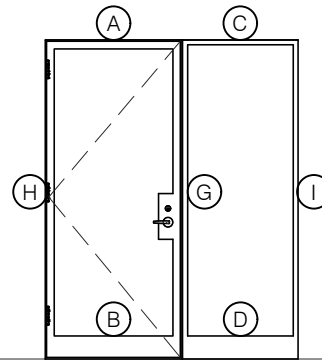

SWING IN
5/8" GLASS

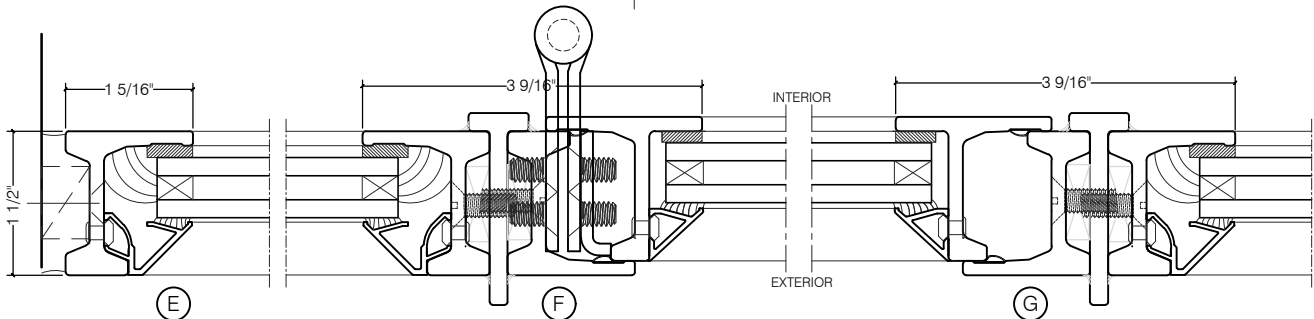
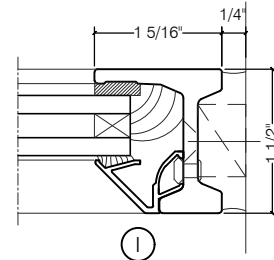
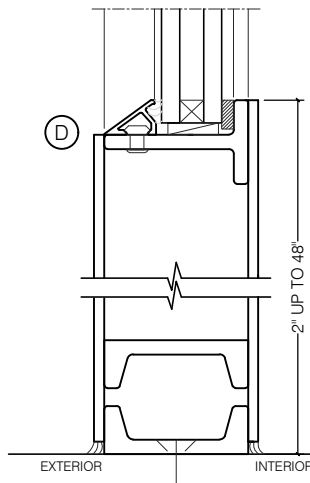
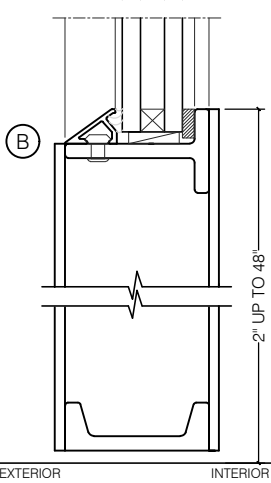
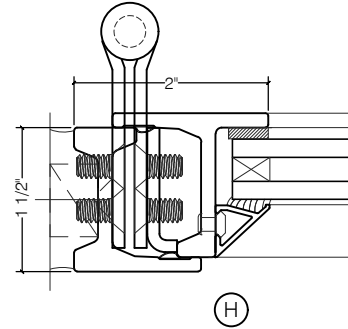
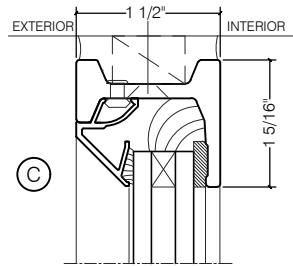
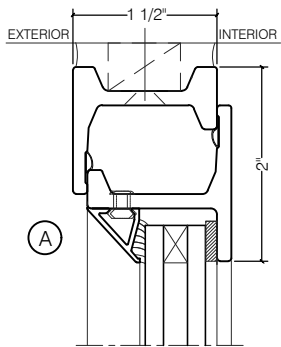

SCALE: 2:1